



High-Precision, Low-Voltage, Micropower Op Amp

MAX480

General Description

The MAX480 is a precision micropower operational amplifier with flexible power-supply capability. Its guaranteed 140 μ V maximum offset voltage (25 μ V typ) is the lowest of any micropower op amp. Similarly, input bias current, input offset current, and drift specifications are within tight limits.

Both the input and output voltage ranges include the negative supply rail, allowing maximum signal range capability in single-supply applications. The MAX480 operates with either a single supply ranging from +1.6V to +36V or dual supplies from ± 0.8 V to ± 18 V. The MAX480 consumes less than 20 μ A, allowing operation in excess of 10,000 hours from a 250mA-hr lithium coin cell. Even with a minimal quiescent current, the amplifier sinks or sources 5mA from its output.

The MAX480 is available in 8-pin DIP and SO packages in commercial, extended, and military temperature ranges.

Applications

Precision Micropower Amplifiers
Micropower Signal Processing
Battery-Powered Analog Circuits

Typical Operating Circuit

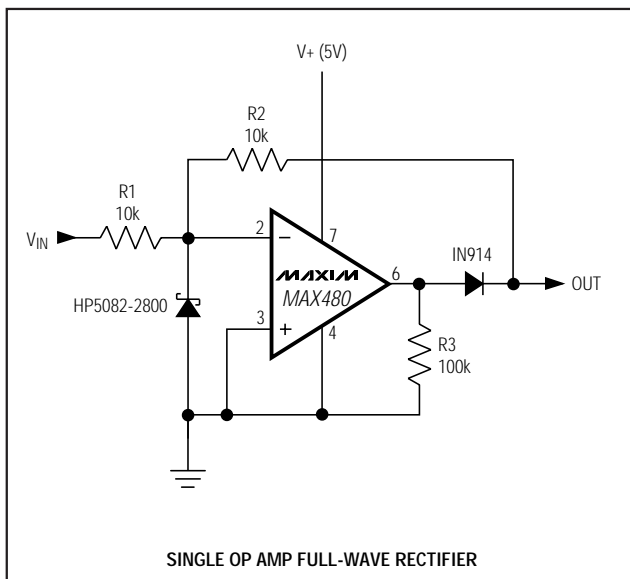

Features

- ◆ Single- or Dual-Supply Operation: +1.6V to +36V, ± 0.8 V to ± 18 V
- ◆ True Single-Supply Operation: Input and Output Voltage Ranges Include Ground
- ◆ 2.0 μ V/ $^{\circ}$ C Max Offset Voltage Drift
- ◆ 20 μ A Max Supply Current
- ◆ 5mA Min Output Drive
- ◆ 140 μ V Max Input Offset Voltage
- ◆ 3nA Max Input Bias Current
- ◆ 500V/mV Min Open-Loop Gain
- ◆ Standard 741 Pinout with Nulling to V-

Ordering Information

| PART | TEMP. RANGE | PIN-PACKAGE |
|-----------|---------------------------------------|---------------|
| MAX480CPA | 0 $^{\circ}$ C to +70 $^{\circ}$ C | 8 Plastic DIP |
| MAX480CSA | 0 $^{\circ}$ C to +70 $^{\circ}$ C | 8 SO |
| MAX480EPA | -40 $^{\circ}$ C to +85 $^{\circ}$ C | 8 Plastic DIP |
| MAX480ESA | -40 $^{\circ}$ C to +85 $^{\circ}$ C | 8 SO |
| MAX480MJA | -55 $^{\circ}$ C to +125 $^{\circ}$ C | 8 CERDIP |

Pin Configuration

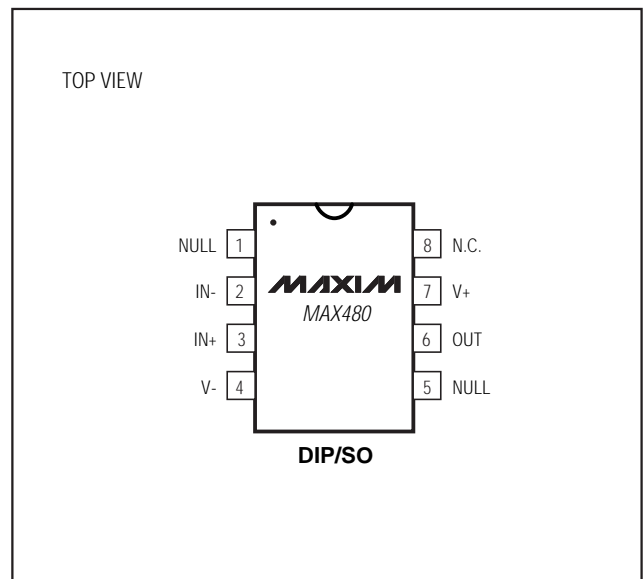

Maxim Integrated Products 1

For free samples & the latest literature: <http://www.maxim-ic.com>, or phone 1-800-998-8800.
For small orders, phone 408-737-7600 ext. 3468.

High-Precision, Low-Voltage, Micropower Op Amp

ABSOLUTE MAXIMUM RATINGS

| | |
|--|--------------------------|
| Supply Voltage (V+ to V-) | ±18V |
| Differential Input Voltage | (V- - 20V) to (V+ + 20V) |
| Common-Mode Input Voltage | (V- - 20V) to (V+ + 20V) |
| Output Short-Circuit Duration | Indefinite |
| Continuous Power Dissipation | |
| Plastic DIP (derate 9.09mW/°C above +70°C) | 727mW |
| SO (derate 5.88mW/°C above +70°C) | 471mW |
| CERDIP (derate 8.0mW/°C above +70°C) | 640mW |

Operating Temperature Ranges

| | |
|--|-----------------|
| MAX480C_A | 0°C to +70°C |
| MAX480E_A | -40°C to +85°C |
| MAX480MJA | -55°C to +125°C |
| Junction Temperature (T _J) | -65°C to +150°C |
| Storage Temperature Range | -65°C to +150°C |
| Lead Temperature (soldering, 10sec) | +300°C |

Stresses beyond those listed under "Absolute Maximum Ratings" may cause permanent damage to the device. These are stress ratings only, and functional operation of the device at these or any other conditions beyond those indicated in the operational sections of the specifications is not implied. Exposure to absolute maximum rating conditions for extended periods may affect device reliability.

ELECTRICAL CHARACTERISTICS

(V_S = ±1.5V to ±15V, T_A = +25°C, unless otherwise noted.)

| PARAMETER | SYMBOL | CONDITIONS | | MIN | TYP | MAX | UNITS |
|------------------------------------|-------------------|--|------------------------|----------|-------|------|-------|
| Input Offset Voltage | V _{OS} | | | | 25 | 140 | μV |
| Input Offset Current | I _{OS} | V _{CM} = 0 | | | 0.2 | 1 | nA |
| Input Bias Current | I _B | V _{CM} = 0 | | | 1 | 3 | nA |
| Large-Signal Voltage Gain | A _{VO} | V _S = ±15V, V _O = ±10V | R _L = 100kΩ | 500 | 1200 | V/mV | |
| | | | R _L = 10kΩ | 200 | 600 | | |
| | | V ₊ = 5V, V ₋ = 0, 1V < V _O < 4V | R _L = 2kΩ | 75 | 250 | | |
| | | | R _L = 10kΩ | 100 | 400 | | |
| Input Voltage | IVR | V ₊ = 5V, V ₋ = 0 | | 0/4 | | V | |
| | | V _S = ±15kV (Note 1) | | -15/13.5 | | | |
| Output Voltage Swing | V _O | V _S = ±15V | R _L = 10kΩ | ±14 | ±14.2 | V | |
| | | | R _L = 2kΩ | ±11 | ±12 | | |
| | V _{OH} | V ₊ = 5V, V ₋ = 0, R _L = 2kΩ | | 4.0 | 4.2 | | |
| | V _{OL} | V ₊ = 5V, V ₋ = 0, R _L = 10kΩ | | | 100 | 500 | μV |
| Common-Mode Rejection Ratio | CMRR | V ₊ = 5V, V ₋ = 0, 0 < V _{CM} < 4V | | 85 | 110 | dB | |
| | | V _S = ±15V, -15V < V _{CM} < 13.5V | | 90 | 130 | | |
| Power-Supply Rejection Ratio | PSRR | | | | 1.0 | 12 | μV/V |
| Slew Rate | SR | V _S = ±15V | | 5 | 12 | | V/ms |
| Supply Current | I _{SY} | V _S = ±1.5V | | | 9 | 15 | μA |
| | | V _S = ±15V | | | 14 | 20 | |
| Capacitive Load Stability | | A _V = +1V/V, no oscillations (Note 2) | | 250 | 650 | | pF |
| Input Noise Voltage | e _{np-p} | f _O = 0.1Hz to 10Hz, V _S = ±15V | | | 3 | | μVp-p |
| Differential-Mode Input Resistance | R _{IN} | V _S = ±15V | | | 30 | | MΩ |
| Common-Mode Input Resistance | R _{INCM} | V _S = ±15V | | | 20 | | GΩ |

High-Precision, Low-Voltage, Micropower Op Amp

MAX480

ELECTRICAL CHARACTERISTICS

($V_S = \pm 1.5V$ to $\pm 15V$, $T_A = T_{MIN}$ to T_{MAX} , unless otherwise noted.)

| PARAMETER | SYMBOL | CONDITIONS | MAX480C | | | MAX480E | | | MAX480M | | | UNITS |
|------------------------------|------------|---|--------------------|------------|------------|----------|------------|------------|------------|------------|-------------------|-------|
| | | | MIN | TYP | MAX | MIN | TYP | MAX | MIN | TYP | MAX | |
| Input Offset Voltage | V_{OS} | | 40 | 220 | | 50 | 250 | 70 | 300 | | μV | |
| Input Offset Voltage Drift | TCV_{OS} | (Note 2) | 0.3 | 2.0 | | 0.3 | 2.0 | 0.3 | 2.0 | | $\mu V/^{\circ}C$ | |
| Input Offset Current | I_{OS} | $V_{CM} = 0$ | 0.2 | 2.0 | | 0.3 | 2.0 | 0.5 | 2.0 | | nA | |
| Input Bias Current | I_B | $V_{CM} = 0$ | 1 | 3 | | 2 | 5 | 3 | 7 | | nA | |
| Large-Signal Voltage Gain | A_{VO} | $V_S = \pm 15V$, $V = \pm 10V$ | $R_L = 100k\Omega$ | 350 | 950 | | 350 | 800 | 60 | 400 | V/mV | |
| | | | $R_L = 10k\Omega$ | 130 | 400 | | 130 | 400 | 45 | 240 | | |
| | | | $R_L = 2k\Omega$ | 55 | 125 | | 55 | 150 | 30 | 110 | | |
| | | $V_+ = 5V$, $V_- = 0$, $1V < V_O < 4V$ | $R_L = 100k\Omega$ | 50 | 360 | | 50 | 280 | 35 | 200 | | |
| | | | $R_L = 10k\Omega$ | 30 | 150 | | 30 | 140 | 22 | 110 | | |
| Input Voltage Range | IVR | $V_+ = 5V$, $V_- = 0$ | 0/3.5 | | | 0/3.5 | | 0/3.5 | | V | | |
| | | $V_S = \pm 15V$ (Note 1) | -15/13.5 | | | -15/13.5 | | -15/13.5 | | | | |
| Output Voltage Swing | V_O | $V_S = \pm 15V$ | $R_L = 10k\Omega$ | ± 13.5 | ± 14 | | ± 13.5 | ± 14 | ± 13.5 | ± 13.7 | V | |
| | | | $R_L = 2k\Omega$ | ± 10.5 | ± 11.8 | | ± 10.5 | ± 11.8 | ± 10.5 | ± 11.5 | | |
| | V_{OH} | $V_+ = 5V$, $V_- = 0$ $R_L = 2k\Omega$ | 3.9 | 4.1 | | 3.9 | 4.1 | 3.9 | 4.1 | | | |
| | V_{OL} | $V_+ = 5V$, $V_- = 0$ $R_L = 10k\Omega$ | 100 | 500 | | 100 | 500 | 100 | 500 | μV | | |
| Common-Mode Rejection Ratio | CMRR | $V_+ = 5V$, $V_- = 0$, $0 < V_{CM} < 3.5V$ | 85 | 110 | | 85 | 110 | 80 | 105 | dB | | |
| | | $V_S = \pm 15V$, $-15V < V_{CM} < 13.5V$ | 90 | 120 | | 90 | 120 | 85 | 115 | | | |
| Power-Supply Rejection Ratio | PSRR | | 1.0 | 12 | | 1.0 | 12 | 3.2 | 15 | $\mu V/V$ | | |
| Supply Current | I_{SY} | $V_S = \pm 1.5V$ | 12 | 25 | | 13 | 25 | 15 | 25 | μA | | |
| | | $V_S = \pm 15V$ | 16 | 30 | | 17 | 30 | 19 | 30 | | | |

Note 1: Guaranteed by CMRR test.

Note 2: Guaranteed by design.

High-Precision, Low-Voltage, Micropower Op Amp

Typical Operating Characteristics

($T_A = +25^\circ\text{C}$, unless otherwise noted.)

INPUT OFFSET VOLTAGE vs. TEMPERATURE

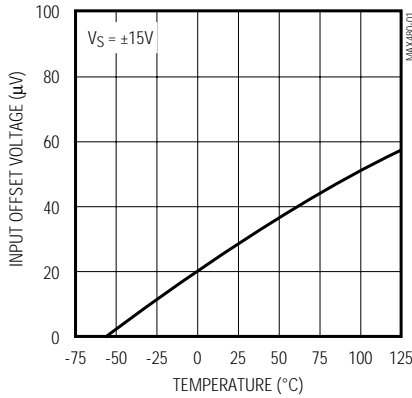

INPUT OFFSET CURRENT vs. TEMPERATURE

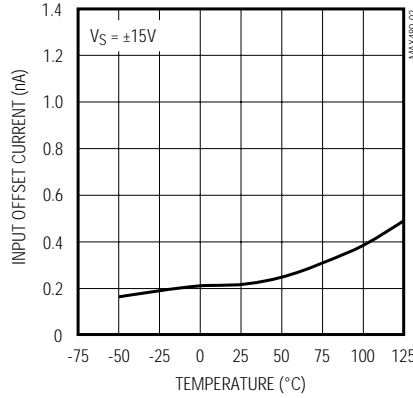

INPUT BIAS CURRENT vs. TEMPERATURE

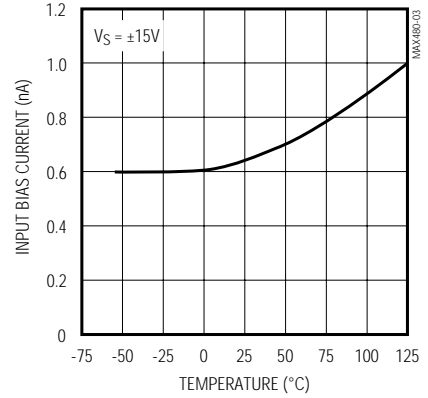

SUPPLY CURRENT vs. TEMPERATURE

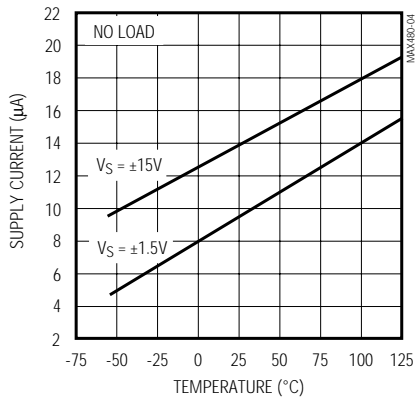

OPEN-LOOP GAIN vs. SINGLE-SUPPLY VOLTAGE

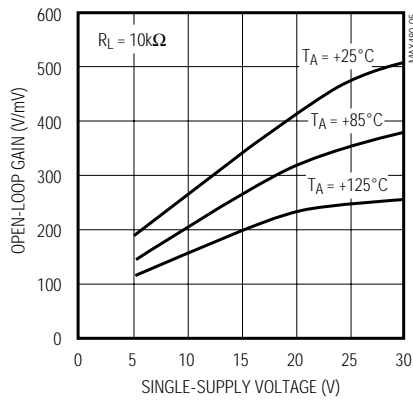

OPEN-LOOP GAIN AND PHASE SHIFT vs. FREQUENCY

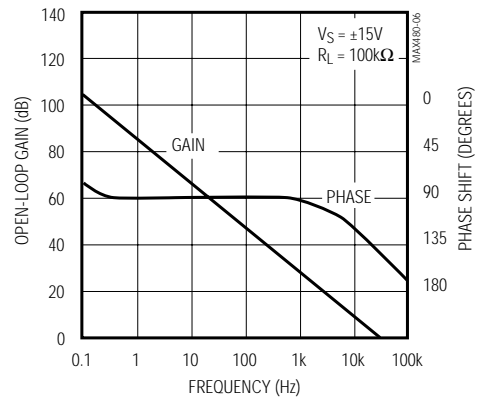

CLOSED-LOOP GAIN vs. FREQUENCY

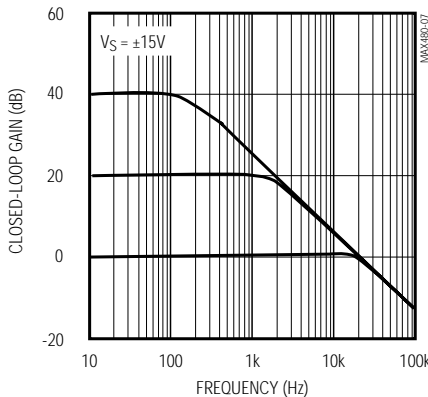

OUTPUT VOLTAGE SWING vs. LOAD RESISTANCE

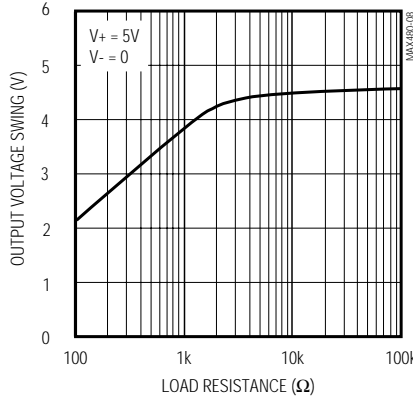

OUTPUT VOLTAGE SWING vs. LOAD RESISTANCE

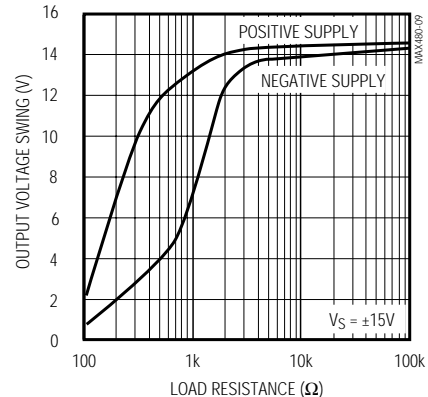

High-Precision, Low-Voltage, Micropower Op Amp

MAX480

Typical Operating Characteristics (continued)

($T_A = +25^\circ\text{C}$, unless otherwise noted.)

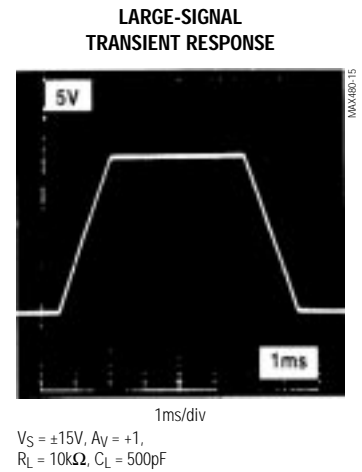
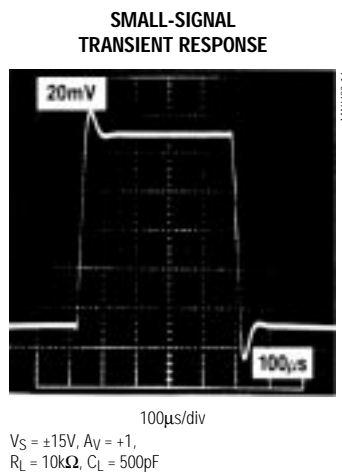
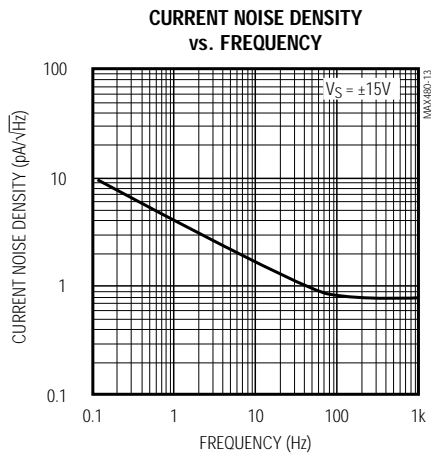
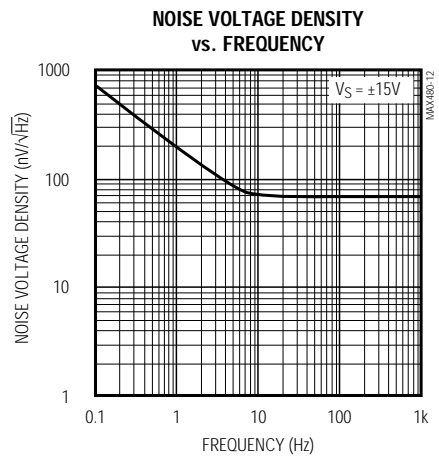
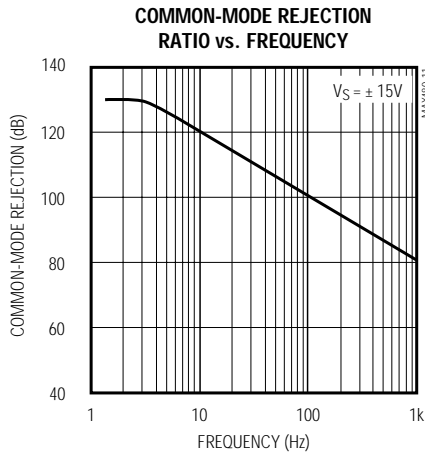
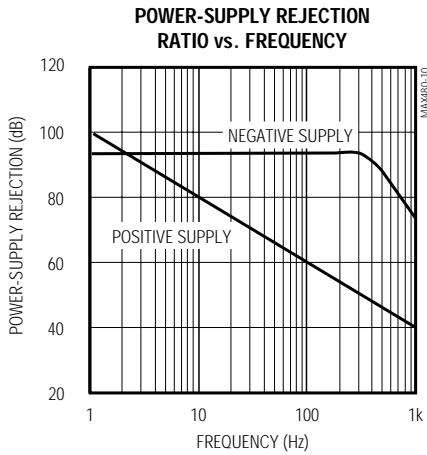

High-Precision, Low-Voltage, Micropower Op Amp

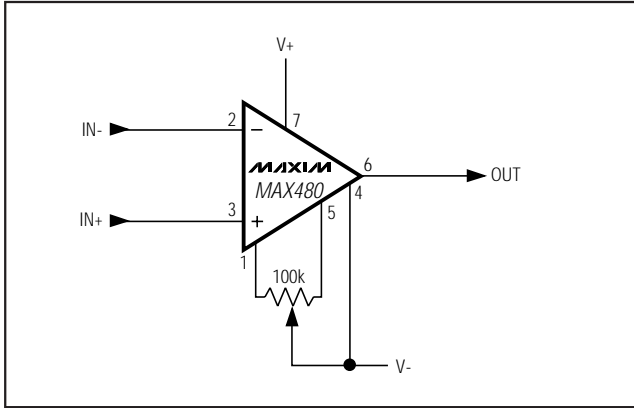

Figure 1. Offset Nulling Circuit

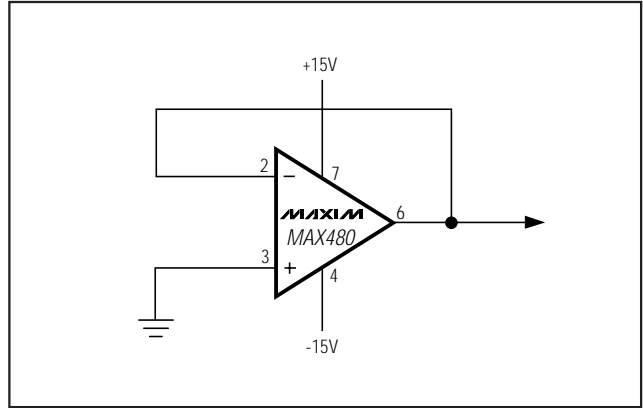

Figure 2. Burn-In Circuit

Package Information

| INCHES | | MILLIMETERS | |
|--------|-------|-------------|------|
| | MIN | MAX | |
| A | 0.053 | 0.069 | 1.35 |
| A1 | 0.004 | 0.010 | 0.10 |
| B | 0.014 | 0.019 | 0.35 |
| C | 0.007 | 0.010 | 0.19 |
| e | 0.050 | | 1.27 |
| E | 0.150 | 0.157 | 3.80 |
| H | 0.228 | 0.244 | 5.80 |
| h | 0.010 | 0.020 | 0.25 |
| L | 0.016 | 0.050 | 0.40 |

| INCHES | | MILLIMETERS | | N | MS012 |
|--------|-------|-------------|------|-------|-------|
| MIN | MAX | MIN | MAX | | |
| D | 0.189 | 0.197 | 4.80 | 5.00 | 8 |
| D | 0.337 | 0.344 | 8.55 | 8.75 | 14 |
| D | 0.386 | 0.394 | 9.80 | 10.00 | 16 |

NOTES:
 1. D&E DO NOT INCLUDE MOLD FLASH
 2. MOLD FLASH OR PROTRUSIONS NOT TO EXCEED .15mm (.006")
 3. LEADS TO BE COPLANAR WITHIN .102mm (.004")
 4. CONTROLLING DIMENSION: MILLIMETER
 5. MEETS JEDEC MS012-XX AS SHOWN IN ABOVE TABLE
 6. N = NUMBER OF PINS

MAXIM PACKAGE FAMILY OUTLINE: SOIC .150" 1/1 21-0041 A
21 SAN GABRIEL DR. SUNNYVALE CA 94065 FAX (415) 737-7744 PROPRIETARY INFORMATION TITLE DOCUMENT CONTROL NUMBER REV

Maxim cannot assume responsibility for use of any circuitry other than circuitry entirely embodied in a Maxim product. No circuit patent licenses are implied. Maxim reserves the right to change the circuitry and specifications without notice at any time.

6 Maxim Integrated Products, 120 San Gabriel Drive, Sunnyvale, CA 94086 408-737-7600